

Product Features

- High Power GaN HEMT for 6.95 to 7.45GHz
- 12.96dB Small Signal Gain at 7.2GHz
- 43.04dBm Typical P_{SAT} at 7.2GHz
- 62% Efficiency at P_{SAT} at 7.2GHz
- 28V Operation

Applications

- Broadband Amplifiers
- Radio Link
- SATCOM
- Radar Application

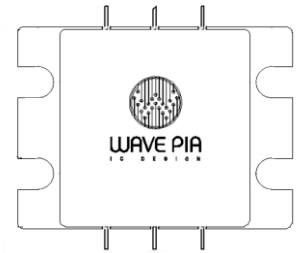

Package Type: 680BH

Absolute Maximum Rating

Parameter	Symbol	Rating	Units	Conditions
Drain-Source Voltage	V_{DSS}	160	Volts	25°C
Gate-to-Source Voltage ³	V_{GS}	-10, +2	Volts	25°C
Storage Temperature ³	T_{STG}	-65, +150	°C	
Operating Junction Temperature ^{1,3}	T_J	225	°C	
Maximum Forward Gate Current ³	I_{GMAX}	30	mA	25°C
Maximum Drain Current ²	I_{DMAX}	1	A	$I_d @ V_d = 10V, V_g = 1V$
Soldering Temperature ³	T_S	245	°C	

1. Continuous use at maximum temperature will affect MTTF.
2. Current limit for long term, reliable operation.
3. After additional updates.

DC Characteristics¹ (Ta=25°C)

Parameter	Symbol	MIN	TYP	MAX	Units	Conditions
Gate Threshold Voltage	$V_{GS(th)}$		-3.5		V_{DC}	$V_{DS} = 10V, I_D = 1mA$
Gate Quiescent Voltage	$V_{GS(Q)}$		-2.43		V_{DC}	$V_{DS} = 28V, I_D = 150mA$
Saturated Drain Current ²	I_{DS}		2000		mA/mm	$V_{DS} = 10V, V_{GS} = 1V$
Drain-Source Breakdown Voltage	V_{BR}	160			V_{DC}	$I_D = 1 mA/mm$

1. Measured on wafer prior to packaging.
2. Scaled from PCM data.

RF Characteristics (Ta=25°C, F0=7.2GHz, Unless otherwise noted)

Parameter	Symbol	MIN	TYP	MAX	Units	Conditions
Gain	G_{SS}		11.9		dB	$V_{DD} = 28V, I_{DQ} = 150mA, RF \text{ Pulse Width} = 200\mu sec, \text{ Duty Cycle} = 10\%$
Saturated Output Power	P_{SAT}		43.04		dBm	$V_{DD} = 28V, I_{DQ} = 150mA, RF \text{ Pulse Width} = 200\mu sec, \text{ Duty Cycle} = 10\%$
Pulsed Drain Efficiency ¹	η		62		%	$V_{DD} = 28V, I_{DQ} = 150mA, RF \text{ Pulse Width} = 200\mu sec, \text{ Duty Cycle} = 10\% @ P_{SAT}$

1. Drain Efficiency = P_{OUT} / P_{DC}

Pulse Signal Performance (Ta=25°C, Measured in the test board amplifier circuit)
 VDD=28V, IDQ=150mA, RF Pulse Width=200µsec, Duty Cycle=10%

Gain, Drain Eff. vs. P_{OUT}

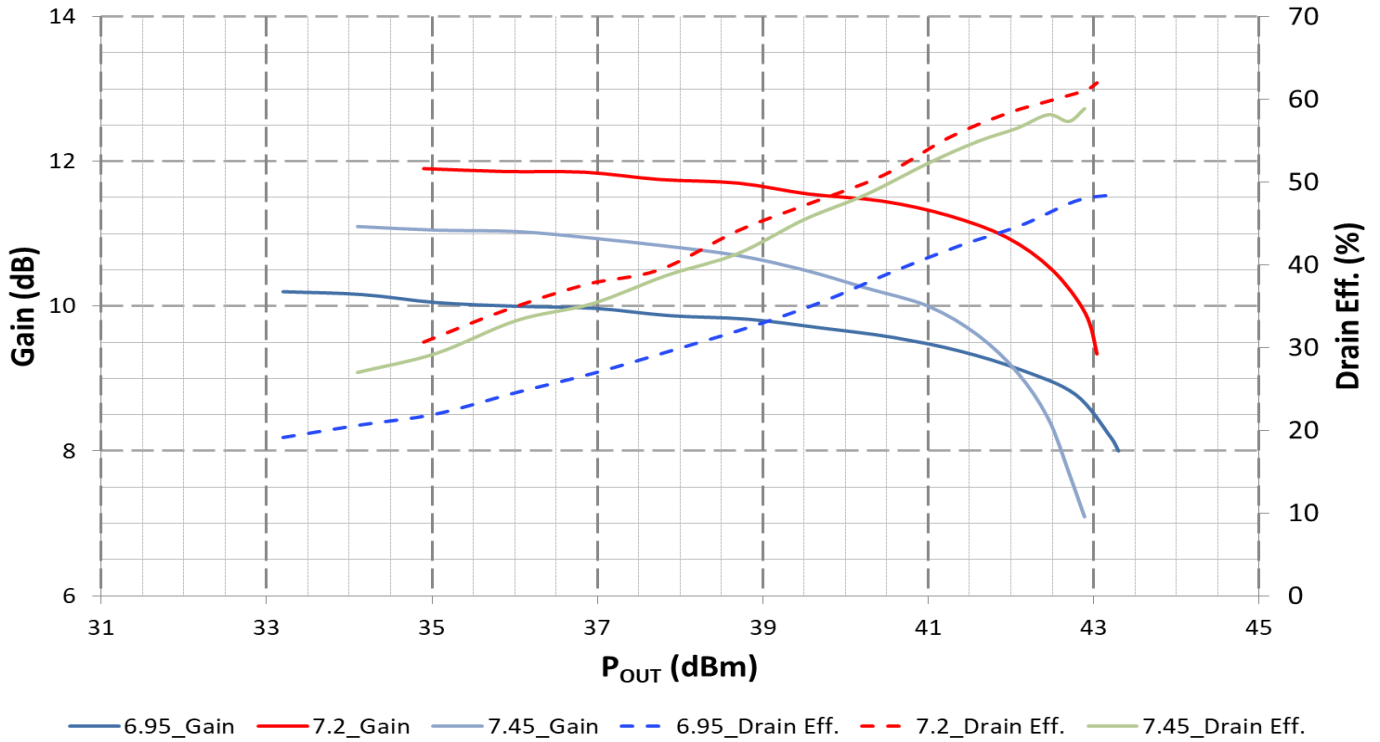

P_{OUT} vs. P_{IN}

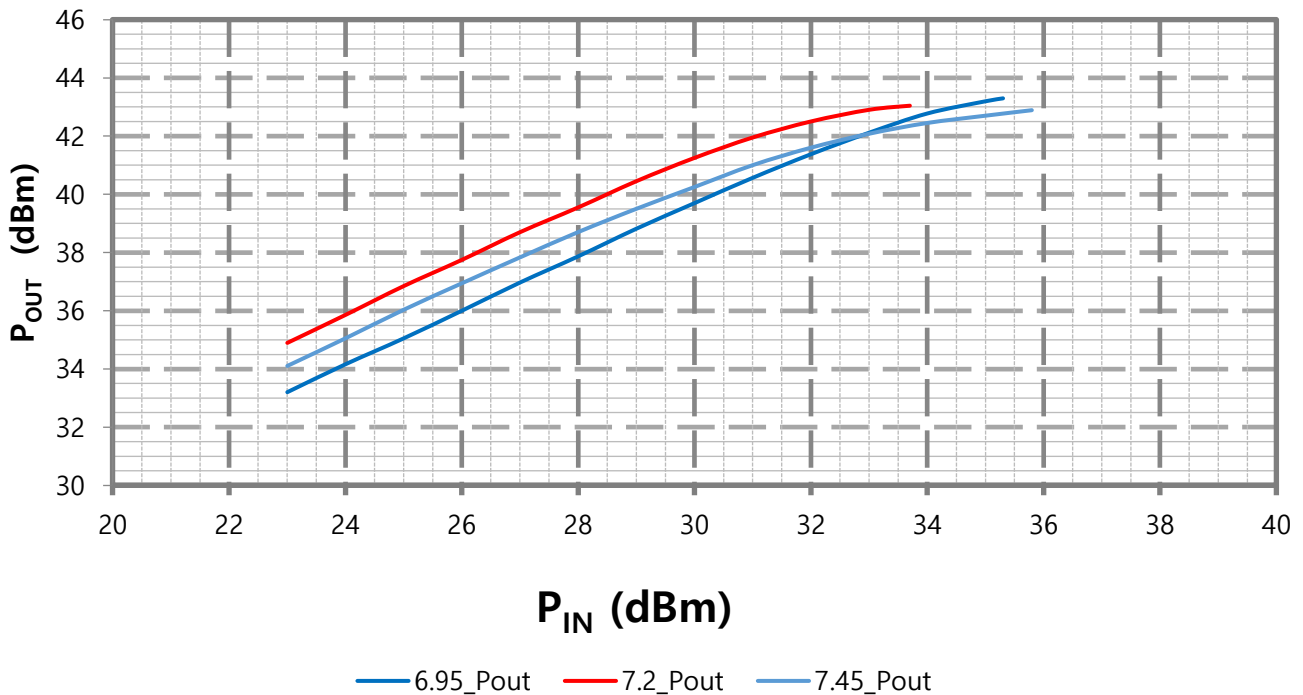

Small Signal Performance (Ta=25°C, Measured in the test board amplifier circuit)
 VDD=28V, IDQ=150mA

S-parameters (dB) vs. frequency

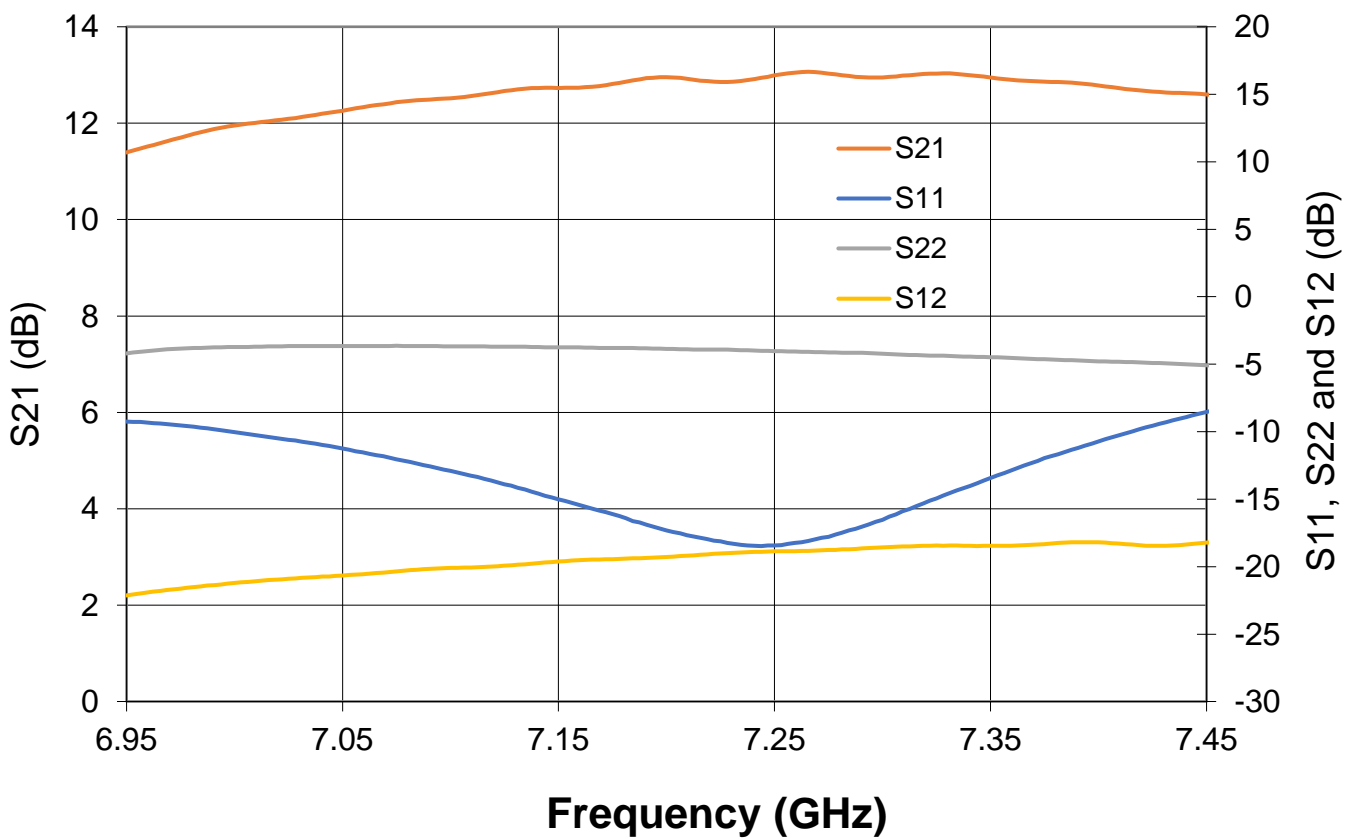

Evaluation Board

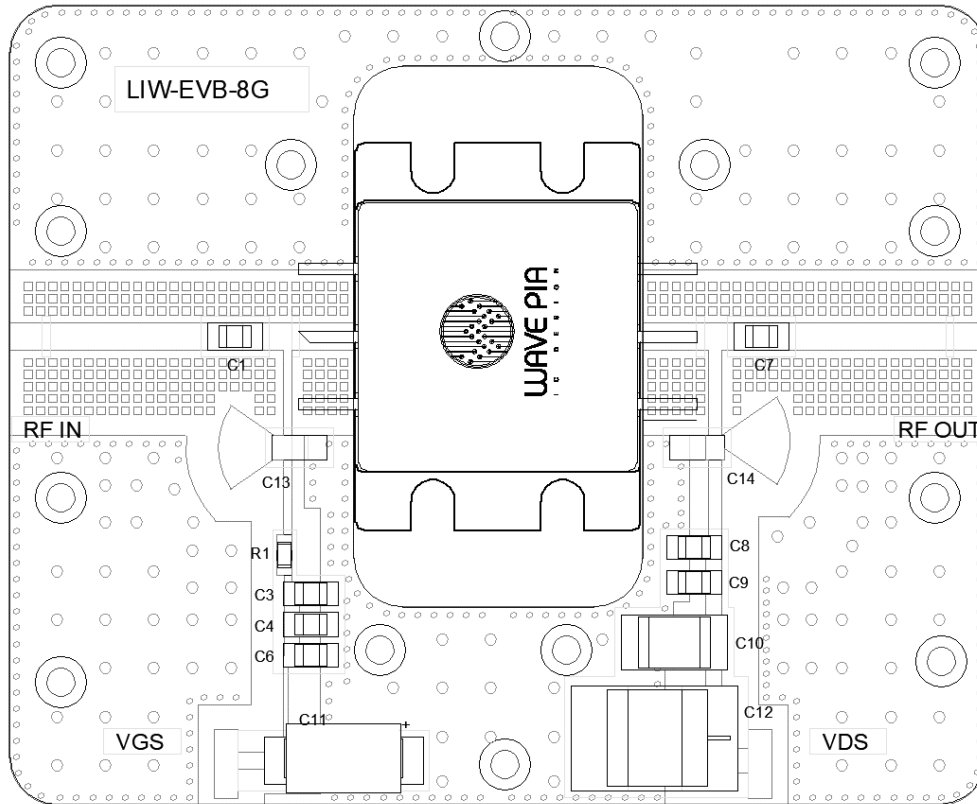

Reference	Value	Description	Package	Manufacturer
C1	0.7pF	High Q Capacitor	2012	Johanson
C2,C8	10pF	High Q Capacitor	2012	Johanson
C3	100pF	Ceramic Capacitor	2012	Samsung
C4	10nF	Ceramic Capacitor	2012	Samsung
C5	1uF	Ceramic Capacitor	2012	Samsung
C6	47uF	Tantalum Capacitor	7343	Vishay
C7	2pF	High Q Capacitor	2012	Johanson
C9	100pF	High Q Capacitor	2012	Johanson
C10	220pF	High Q Capacitor	2012	Johanson
C11	470nF	High V Capacitor	4532	Johanson
C12	47uF	Tantalum Capacitor	7360	Vishay
R1	10 ohm	Chip Resistor	1608	Samsung
TR1		WP287P20015MH	680MH	WAVEPIA
PCB	RO4350B 30mil 1oz			Rogers

Product Dimension

- Package Type: 680MH (Through hole)
- Unit: mm

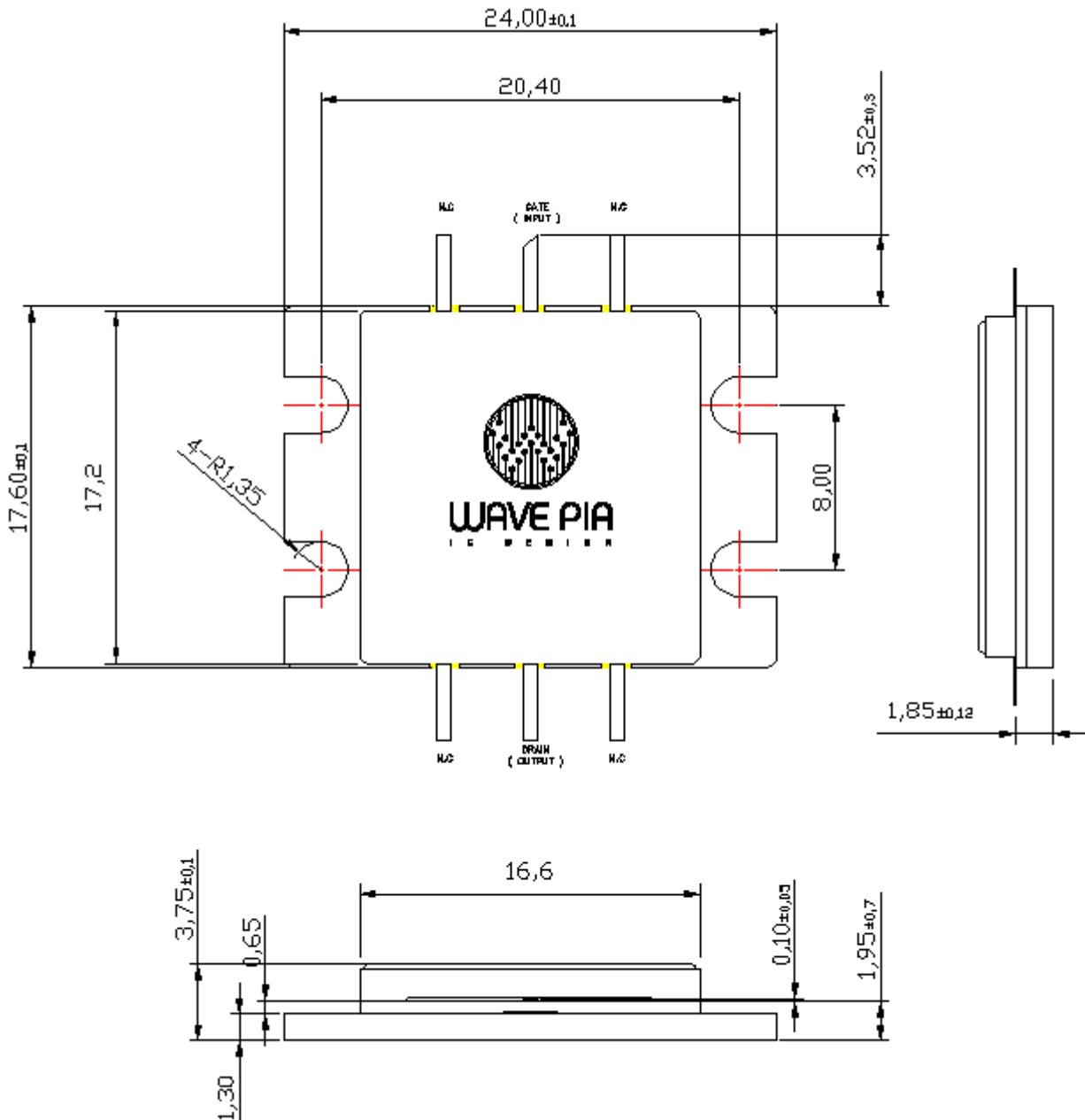

Part Number System

W P 2 8 7 P 2 0 1 5 M H

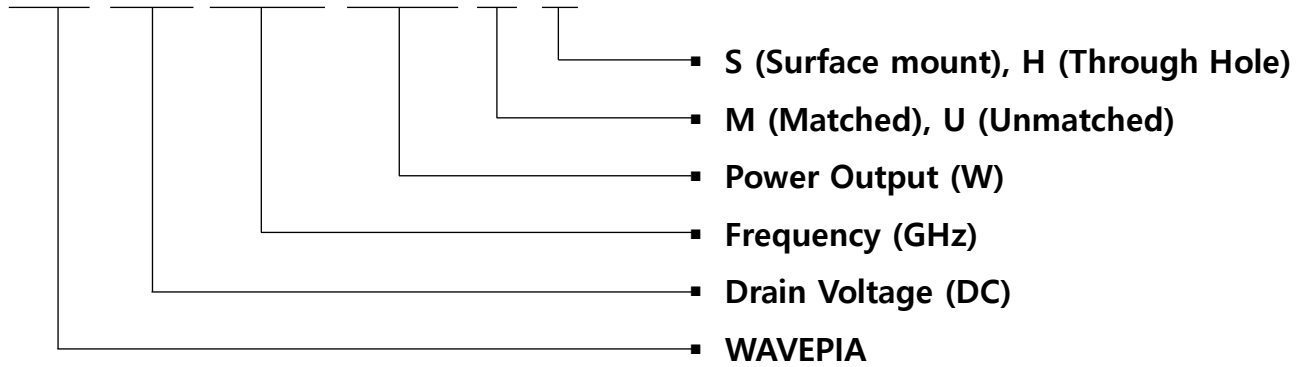

Parameter	Value	Units
Drain Voltage	28	V
Lower Frequency	6.95	GHz
Upper Frequency	7.45	GHz
Output Power	15	W
Transistor Type	Matched	-
Package	H: Through hole	-